

5530
27" Steel Storage Cabinet
69 cm Acier Meuble De Rangement
27 Pulg Acero Almacenamiento Cabinet

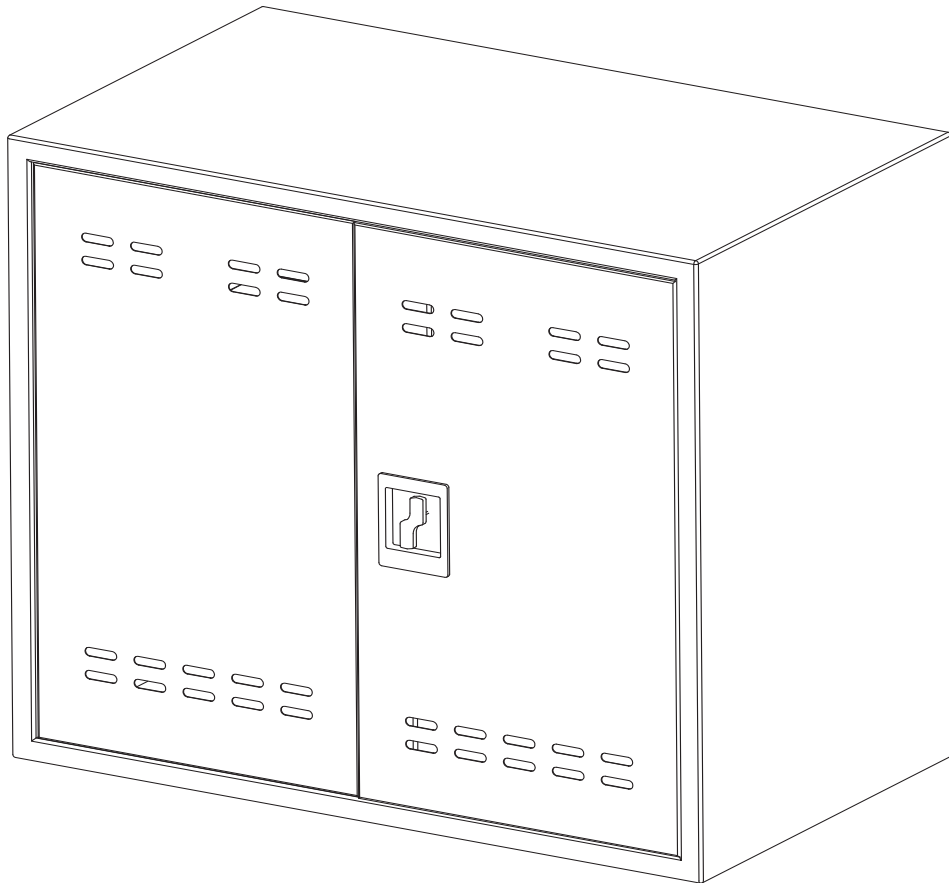

PRODUCT WARRANTY is available online at: www.safcoproducts.com

• LA GARANTIE DU PRODUIT est
disponible sur l'Internet : www.safcoproducts.com

• LA GARANTÍA DEL PRODUCTO está
disponible en la Internet: www.safcoproducts.com

For questions or concerns, please call **1-800-664-0042**
available Monday-Friday 7:30 AM to 5:00 PM (Central Time) (English-speaking operators)

Si vous avez des questions pour poser ou les préoccupations
pour exprimer, connecter au **1-800-664-0042**
de 7H30 à 17H00 (Heure centrale) (Opérateurs de langue anglaise)

Si usted tiene preguntas o preocupaciones,
por favor llame **1-800-664-0042**
de 7:30 AM a 5:00 PM (Hora Central) (Operadores que hablan inglés)

PARTS LIST/ LISTE DES PIÈCES/LISTA DE PIEZAS

CODE	DESCRIPTION	QTY	PART NO.
(A)	Cabinet Shell/ Meuble De Coquille/ Gabinete Cáscara	1	100553001
(B)	Mounting Bracket/ Bracket De Montage/ Montaje Ménsula	2	100553002
(C)	Shelf/ Étagère/ Estante	1	100553003

§ **Note: When corresponding about parts, be sure to state color: Gray (GR), Tan (TN).**





§ *Noter: Quand correspondre au sujet de parties, soyez sûr d'affirmer la couleur: Gris (GR), Hâle (TN).*

§ *Nota: Al corresponder sobre las piezas, esté seguro declarar el color: Gris (GR), Bronceado (TN).*

TOOLS REQUIRED: Socket Wrench, Pencil, Drill with 5/32" bit, Level, Measuring Tape, Stud Finder

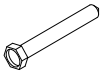
OUTILS REQUIS: Clé À Douille, Crayon, Perceuse avec mèche de 4 mm, Niveau, Mètre ruban, Localisateur De Montants

HERRAMIENTAS REQUERIDAS: Llave De Tubo, Lápiz, Taladro con broca de 5/32 pulg, Nivel, Cinta métrica, Buscador de estudios

HARDWARE PACK / PAQUET MATÉRIEL / PAQUETE MATERIAL 90000073				
D  Wall Anchor Anclaje Mural Anclaje De Pared Qty. / Qte. / Cant.: 2 #920000150	E  Lag Screw 1/4x2" Vis De Rappel .635cmX5cm Tornillo de montaje Qty. / Qte. / Cant.: 6 #905000149	F  Shelf Clip Clip Étagère Estante Del Clip Qty. / Qte. / Cant.: 4 #920000149	G  Keys (Not Shown) Clés (non représenté) Llaves (No se muestra) Qty. / Qte. / Cant.: 2 #920000148	H  Washer Rondelle Arandela Qty. / Qte. / Cant.: 6 #915000024

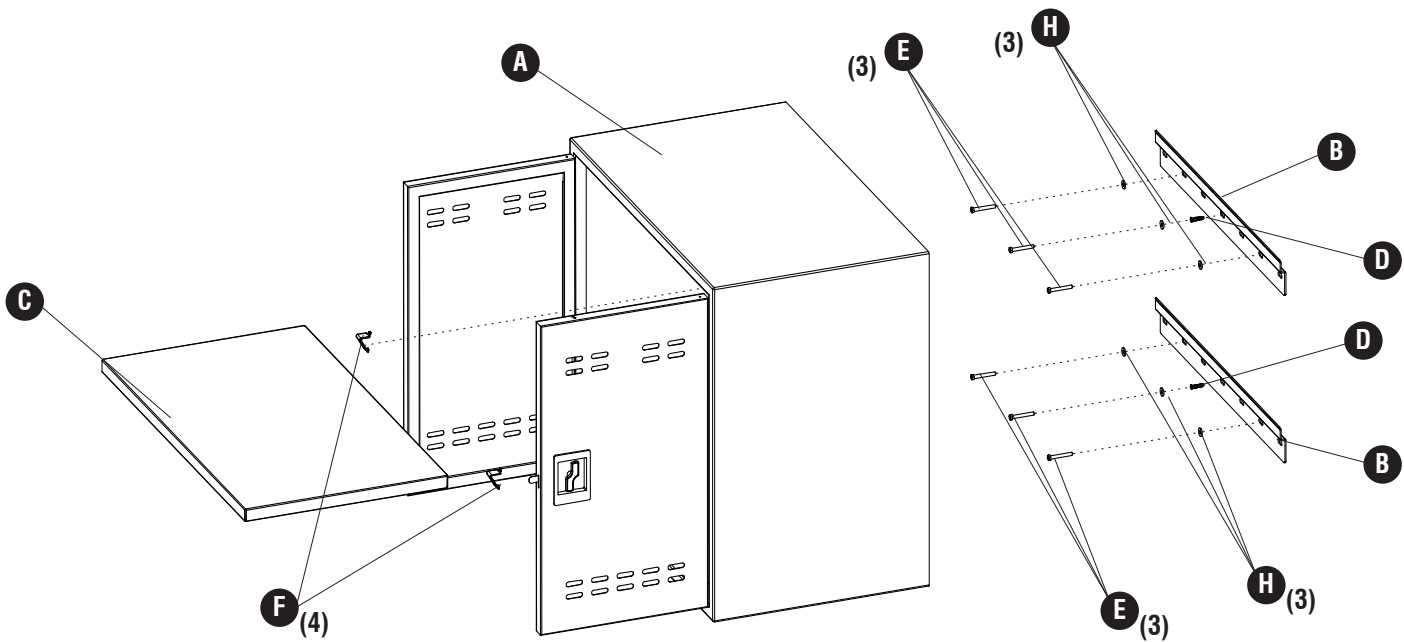

1

Note: Keep mounting bracket edges flush with each other
Noter: Garder bords du support de montage de niveau avec l'autre
Nota: Mantenga los bordes del soporte de montaje al ras con los demás

For 16" on center spacing. Locate studs on wall. Then mark your holes to drill.

Pour 40.64cm sur entraxe. Localisez les montants sur le mur. Puis marquez vos trous à percer.

De 16pulg en el espacio de centro. Localiza pernos prisioneros en la pared. Luego marca tu agujeros para perforar.

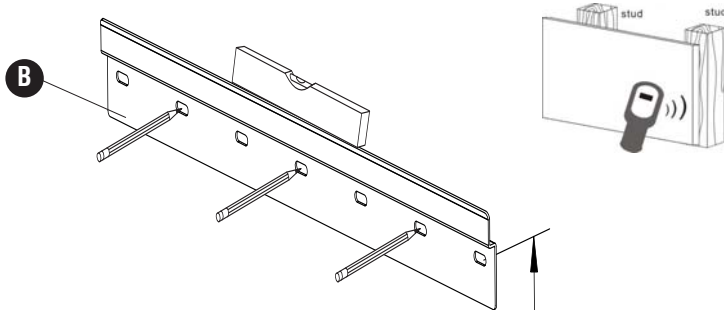

17.75
45cm
17.75pulg

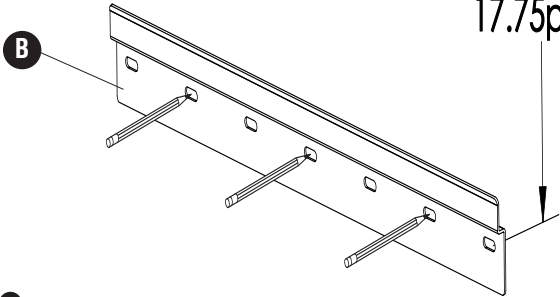

OR
OU
O

Note: Keep mounting bracket edges flush with each other
Noter: Garder bords du support de montage de niveau avec l'autre
Nota: Mantenga los bordes del soporte de montaje al ras con los demás

For 24" on center spacing. Locate studs on wall. Then mark your holes to drill.

Pour 60.96cm sur entraxe. Localisez les montants sur le mur. Puis marquez vos trous à percer.

De 24pulg en el espacio de centro. Localiza pernos prisioneros en la pared. Luego marca tu agujeros para perforar.

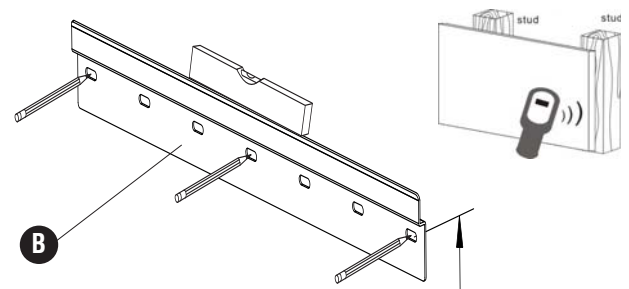

17.75
45cm
17.75pulg

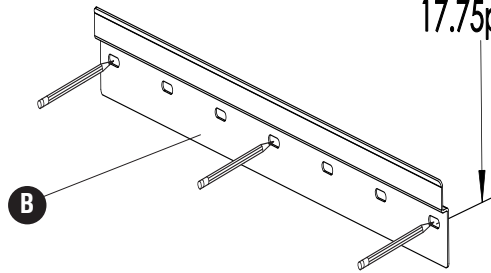

2

For 16" on center spacing
Pour 40.64cm sur entraxe
De 16pulg en el espacio de centro

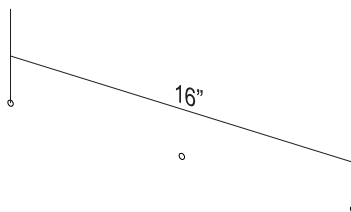
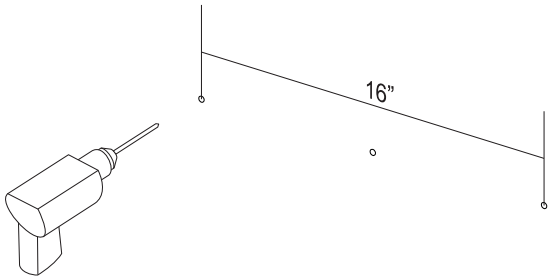

For 24" on center spacing
Pour 60.96cm sur entraxe
De 24pulg en el espacio de centro

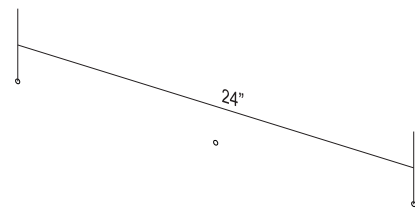
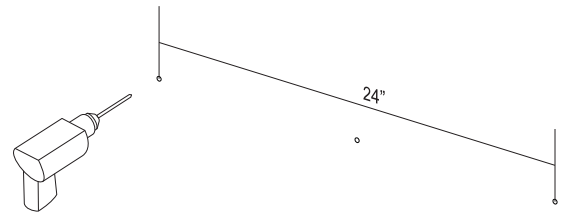

OR
OU
O

3 **D**  (2)

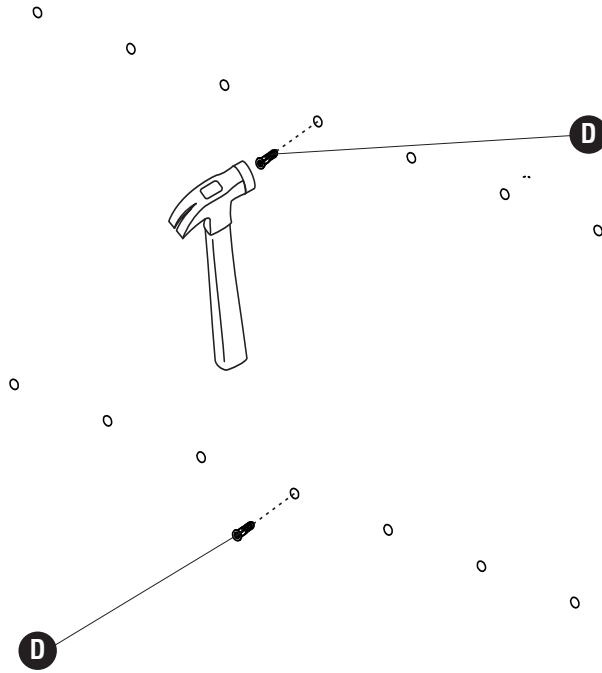

4 **E**  (6) **H**  (6)

For 16" on center spacing. Do not over tighten screws.
Pour 40.64cm sur entraxe. Ne pas trop serrer les vis.
 De 16pulg en el espacio de centro. No apriete demasiado los tornillos.

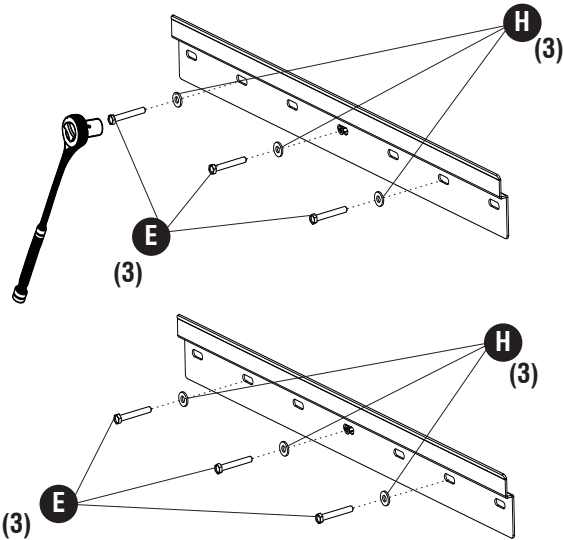

E  (6) **H**  (6)

For 24" on center spacing. Do not over tighten screws.
Pour 60.96cm sur entraxe. Ne pas trop serrer les vis.
 De 24pulg en el espacio de centro. No apriete demasiado los tornillos.

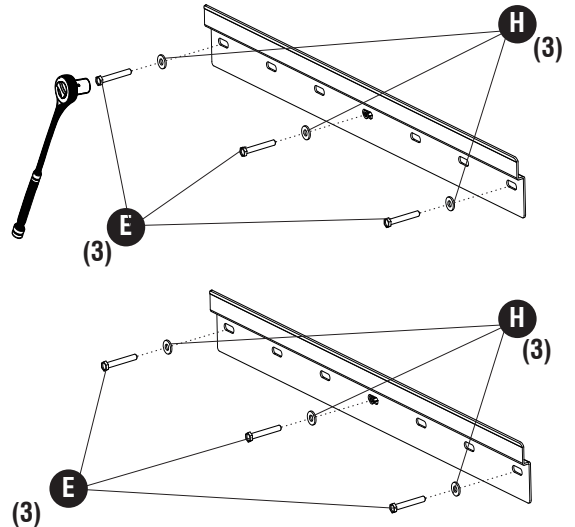

OR
 OU
 O

5

24" Spacing Shown
60.96cm Espacement Montré
24pulg Espaciado que se muestra

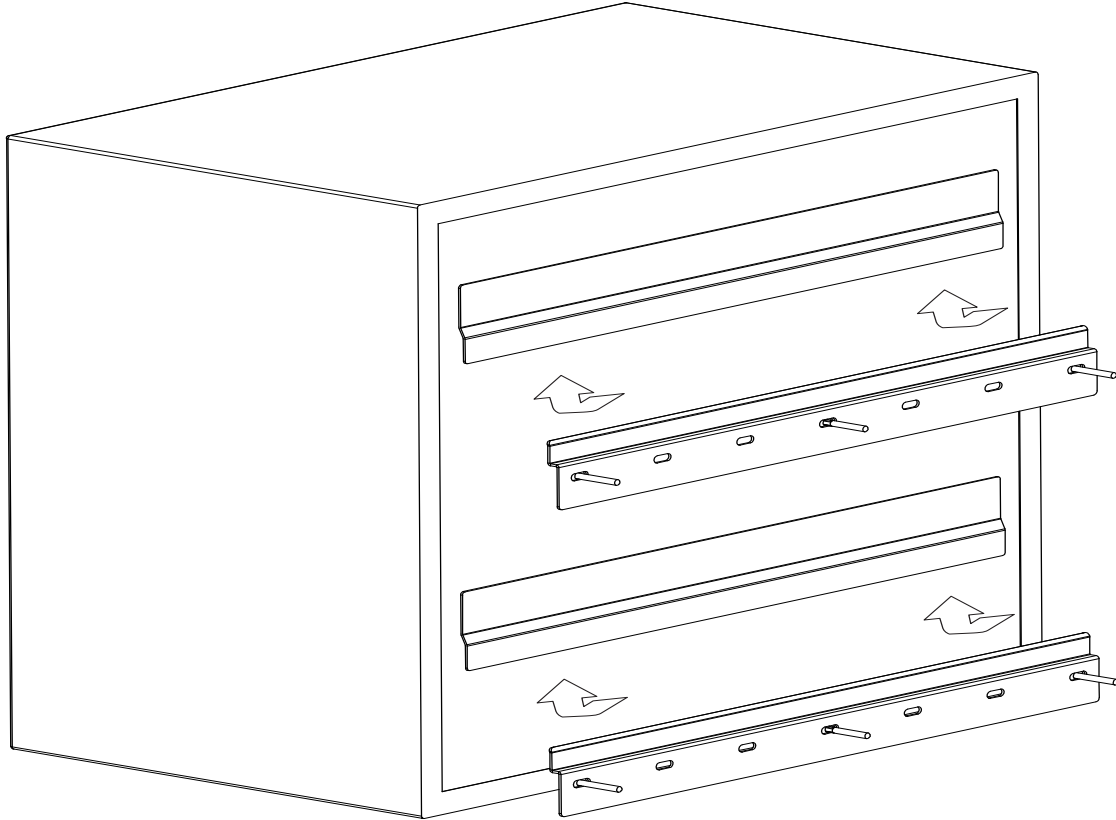

6 F (4)



Note: Located Front Left Corner And Back Right Hand Corner. Unscrew And Throw Away Shipping Braces.

Noter: Situé avant gauche dos et coin coin droit.

Dévissez et jeter des accolades de l'expédition.

Nota: Encuentra la parte posterior izquierda delantera y derecha zona. Retire y deseché las abrazaderas de envío.

