

## USE WITH METAL AND CORRUGATED FLAT FILE DRAWERS

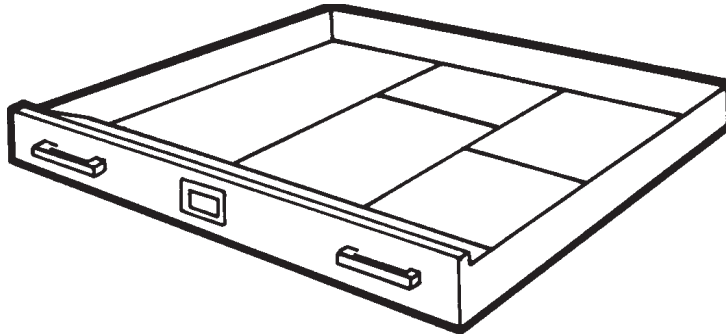

- 1 Use desired sheet size as guides.  
Draw light lines between them.

Caution: avoid placing dividers in path of paper holder.

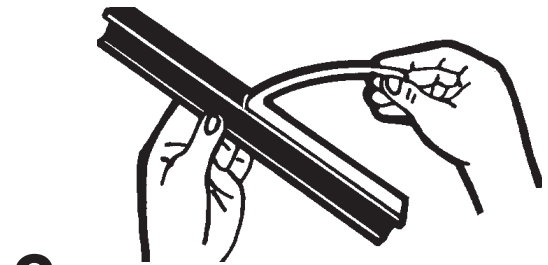
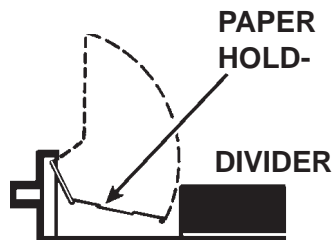

- 2 Peel off backing.

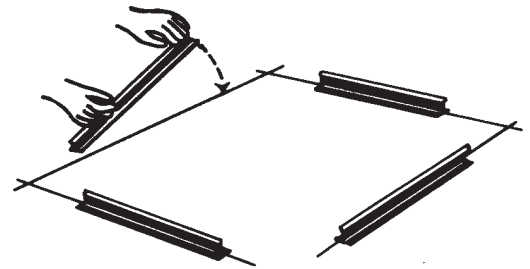

- 3 Align divider to line and press down.

## SAFCO SÉPARATEUR DE CLASSEUR HORIZONTAL

NUMÉRO DE MODÈLE **4980**

### UTILISER AVEC LES TIROIRS MÉTALLIQUES OU DE CARTON ONDULÉ DE CLASSEUR HORIZONTAL

- 1 Utiliser les feuilles de la grandeur voulue comme guides.  
Tracer des lignes minces entre les feuilles.

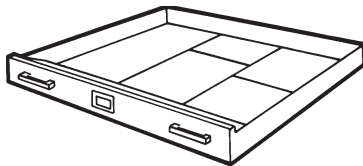

Attention : Ne pas mettre de séparateur dans l'espace où le serre-papiers se déplace.

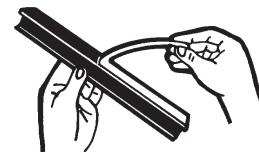
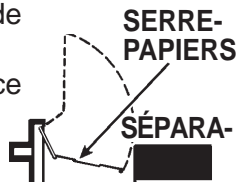

- 2 Enlever la bande protectrice.

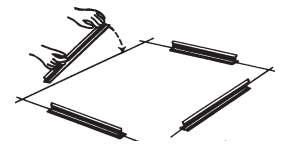

- 3 Aligner le séparateur sur la ligne, puis appuyer sur lui.

## SAFCO SEPARADOR PARA ARCHIVADOR HORIZONTAL

MODELO NÚMERO **4980**

### PARA USARSE CON CAJONES ACANALADOS Y DE METAL DEL ARCHIVADOR HORIZONTAL

- 1 Como guías, utilice hojas del mismo tamaño que las que desea archivar. Trace líneas débiles entre las hojas.

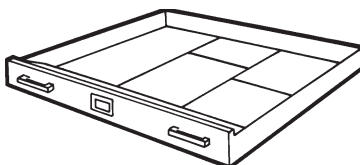

Precaución: No sitúae los separadores en la trayectoria del pisapapeles.

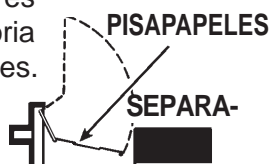

- 2 Desprenda el material protector.

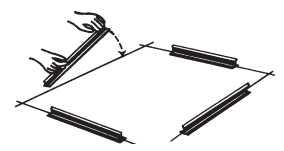

- 3 Alinee los separadores en las líneas que trazó y presione.