

**FLUKE®**

# **51 & 52 Series II**

Thermometer

Users Manual

English

September 1999 Rev.2, 11/10

© 1999-2010 Fluke Corporation, All rights reserved.

All product names are trademarks of their respective companies. Specifications subject to change without notice

### **Limited Warranty & Limitation of Liability**

This Fluke product will be free from defects in material and workmanship for 3 years from the date of purchase. This warranty does not cover fuses, disposable batteries or damage from accident, neglect, misuse or abnormal conditions of operation or handling. Resellers are not authorized to extend any other warranty on Fluke's behalf. To obtain service during the warranty period, send your defective tester to the nearest Fluke Authorized Service Center with a description of the problem.

THIS WARRANTY IS YOUR ONLY REMEDY. NO OTHER WARRANTIES, SUCH AS FITNESS FOR A PARTICULAR PURPOSE, ARE EXPRESSED OR IMPLIED. FLUKE IS NOT LIABLE FOR ANY SPECIAL, INDIRECT, INCIDENTAL OR CONSEQUENTIAL DAMAGES OR LOSSES, ARISING FROM ANY CAUSE OR THEORY. Since some states or countries do not allow the exclusion or limitation of an implied warranty or of incidental or consequential damages, this limitation of liability may not apply to you.

Fluke Corporation  
P.O. Box 9090  
Everett WA  
98206-9090

Fluke Europe B.V.  
P.O. Box 1186  
5602 B.D. Eindhoven  
The Netherlands

To register your product, visit [www.fluke-warranty.com](http://www.fluke-warranty.com)

# Table of Contents

Title	Page
Introduction .....	1
Contacting Fluke.....	1
Getting Started .....	4
Components .....	5
Display Elements.....	6
Buttons .....	7
Using the Thermometer.....	9
Changing Setup Options .....	9
Entering or Exiting Setup.....	9
Setup Options.....	9
Changing a Setup Option .....	10
Measuring Temperatures .....	11
Connecting a Thermocouple.....	11
Displaying Temperatures.....	11
Holding the Displayed Readings.....	12
Viewing the MIN, MAX, and AVG Readings .....	12
Using the Offset to Adjust for Probe Errors .....	12

Maintenance .....	13
Replacing the Batteries .....	13
Cleaning the Case and Holster .....	13
Calibration .....	13
Specifications.....	13
Environmental .....	13
General .....	14
80 PK-1 Thermocouple (supplied with thermometer) .....	14
Electrical .....	14
Replacement Parts and Accessories .....	15

# 51 & 52 Series II

## Introduction

The Fluke Model 51 and Model 52 Thermometers (“the thermometer”) are microprocessor-based, digital thermometers designed to use external J-, K-, T-, and E-type thermocouples (temperature probes) as temperature sensors.

Use the thermometer only as specified in this manual. Otherwise, the protection provided by the meter may be impaired.

Refer to safety information in Table 1 and meter symbols in Table 2.

## Contacting Fluke

To order accessories, receive assistance, or locate the nearest Fluke distributor or Service Center, call:

1-888-99-FLUKE (1-888-993-5853) in USA  
1-800-36-FLUKE (1-800-363-5853) in Canada  
+31-402-678-200 in Europe  
+81-3-3434-0181 in Japan  
+65-738-5655 in Singapore  
+1-425-446-5500 from other countries

Address correspondence to:

Fluke Corporation	Fluke Europe B.V.
P.O. Box 9090	P.O. Box 1186
Everett, WA 98206-9090	5602 BD Eindhoven
USA	The Netherlands

Visit us on the World Wide Web at: [www.fluke.com](http://www.fluke.com).

To register your product, visit <http://register.fluke.com>.

**Table 1. Safety Information**

** Warning**

**A Warning identifies conditions and actions that pose hazards to the user. To avoid electrical shock or personal injury, follow these guidelines:**

- **Before using the thermometer inspect the case. Do not use the thermometer if it appears damaged. Look for cracks or missing plastic. Pay particular attention to the insulation around the connectors.**
- **Disconnect the thermocouple(s) from the thermometer before opening the case.**
- **Replace the batteries as soon as the battery indicator (🔋) appears. The possibility of false readings can lead to personal injury.**
- **Do not use the thermometer if it operates abnormally. Protection may be impaired. When in doubt, have the thermometer serviced.**
- **Reflective objects result in lower than actual temperature measurements. These objects pose a burn hazard.**
- **Do not operate the thermometer around explosive gas, vapor, or dust.**
- **Do not connect to voltages > 30 V ac rms, 42 V pk, 60 V dc from earth ground.**

Table 1. Safety Information (cont.)

**⚠ Warning (cont.)**





- **Model 52:** Measurement errors may occur if voltages on the measurement surfaces result in potentials greater than 1 V between the two thermocouples. When potential differences are anticipated between the thermocouples, use electrically insulated thermocouples.
- When servicing the thermometer, use only specified replacement parts.
- Do not use the thermometer with any part of the case or cover removed.

**Caution**

**A Caution identifies conditions and actions that may damage the meter or the equipment under test.**

- Use the proper thermocouples, function, and range for your thermometer.
- Do not attempt to recharge the batteries.
- To prevent explosion, do not throw batteries into a fire.
- Follow local laws or regulations when disposing of batteries.
- Match the + and – polarities of the battery with the battery case.

**Table 2. International Symbols**

	Refer to the manual for information about this feature.		Complies with European Union directives.
	Battery.		Complies with relevant Canadian Standards Association directives.

## **Getting Started**

Everything in this *Users Manual* applies both to Models 51 and 52 unless otherwise indicated.

To become familiar with the thermometer, study the following:

- Figure 1 and Table 3 describe the components.
- Figure 2 and Table 4 describe the display.
- Table 5 describes the functions of the buttons.

Then read the following sections.



**Components**

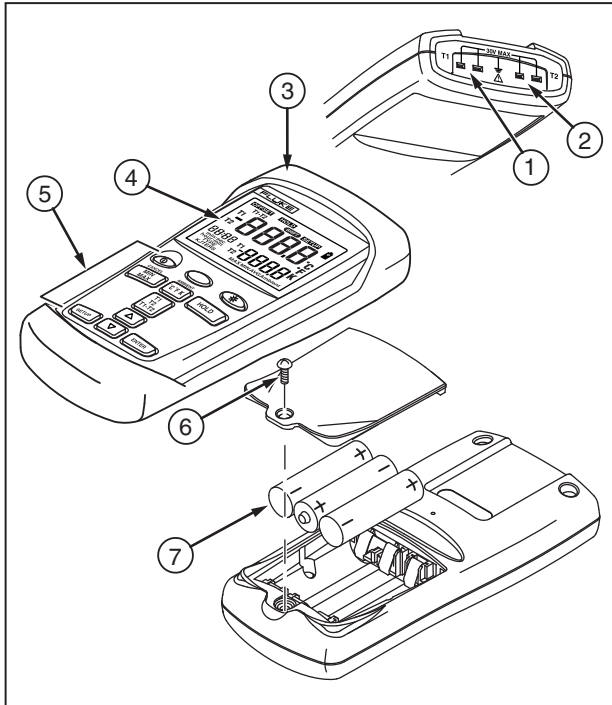

aas01f.eps

**Figure 1. Components**

**Table 3. Components**

①	Thermocouple T1 input
②	<i>Model 52:</i> Thermocouple T2 input
③	Holster
④	Display
⑤	Buttons
⑥	Battery door
⑦	Batteries

## Display Elements

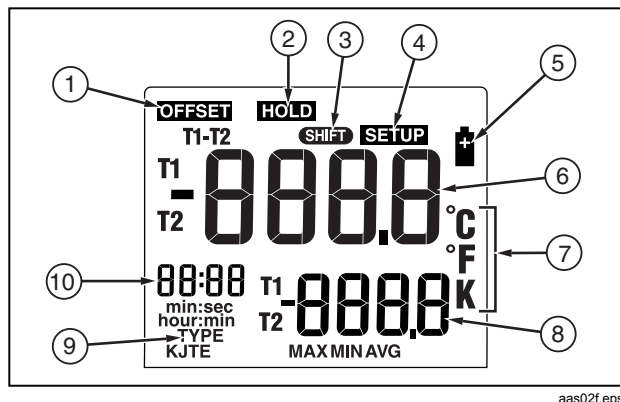



















Figure 2. Display Elements

Table 4. Display Elements











①	The thermocouple measurement includes an offset. See "Changing Setup Options."
②	The displayed readings do not change.
③	A shift function is in progress.
④	Setup is in progress.
⑤	Low battery. Replace the batteries.
⑥	Primary Display. <i>Model 51:</i> T1 reading. <i>Model 52:</i> T1, T2, or T1-T2 reading.
⑦	The temperature unit.
⑧	Secondary Display: MAX, MIN, AVG, or offset. <i>Model 52:</i> T1 or T2 reading.
⑨	The thermocouple type.
⑩	Time Display: The elapsed time.

**Buttons**

**Table 5. Buttons**

	<p>Press  to turn the thermometer on or off.</p>
 (Shift function)	<p>Press ,  (CANCEL) to stop displaying the minimum, maximum, and average readings in the secondary display.</p>
	<p>Press  to turn the backlight on and off. The backlight turns off after 2 minutes without any button presses. If the battery is low, the backlight is disabled.</p>
	<p>Press  to step through the maximum, minimum, and average readings. When viewing logged readings, shows the maximum, minimum, and average of the logged readings.</p> <p>Press ,  (CANCEL) to turn off this display.</p>
	<p>Press  to switch between Celsius (°C), Fahrenheit (°F), and Kelvin (K).</p>
	<p>Press  to freeze or unfreeze the displayed readings.</p> <p>Press  when turning on the thermometer to test the display. All display elements appear.</p>
	<p><i>Model 52:</i> Press  to toggle showing the T1, T2, and T1-T2 (differential temperature measurement) in the primary or secondary display.</p>

**Table 5. Buttons (cont.)**

	Press  to start or exit Setup. (See "Changing Setup Options.")
	Press  to scroll to the Setup option you want to change. Press  to increase the displayed setting.
	Press  to scroll to the Setup option you want to change. Press  to decrease the displayed setting.
	Press  to enter a Setup option. Press  again to store the displayed setting in memory.

## Using the Thermometer

1. Plug the thermocouple(s) into the input connector(s).
2. Press  to turn on the thermometer.

After 1 second the thermometer displays the first reading. If no thermocouple is plugged into the selected input or the thermocouple is "open," the display shows "- - -"

## Changing Setup Options

Use Setup to change the thermocouple type, offset, sleep mode, and line frequency settings.

The thermometer stores the settings in its memory. Setup settings reset only when the batteries are removed for more than 2 minutes.

## Entering or Exiting Setup







When the thermometer is in Setup mode, the display shows **SETUP**.

- Press  to start or exit Setup.

## Setup Options

Option	Menu Item	Settings
Thermocouple Type	<b>TYPE</b>	<b>J, K, T, or E</b>
Offset	<b>OFFSET</b>	<b>T1 or T2 (Model 52)</b>
Sleep Mode	<b>SLP</b>	<b>on</b> (sleep mode on) or <b>OFF</b> (sleep mode off)
Line Frequency	<b>LINE</b>	<b>50 H</b> (50 Hz) or <b>60 H</b> (60 Hz)

### **Changing a Setup Option**

1. Press  or  to scroll to the setup option you want to change.
2. Press  to indicate that you want to change this setting.
3. Press  or  until the setting you want to use appears on the display.
4. Press  to store the new setting in memory.

#### *Notes*

*Setup is disabled in MIN MAX mode.*

#### *Offset:*

*The primary display shows the temperature plus the offset and the secondary display shows the offset. Remember to reset the offset to 0.0 when it is no longer needed. The offset automatically resets to 0.0 when you change the thermocouple type. Model 52: You can store individual offsets for T1 and T2.*

#### *Sleep mode:*

*The thermometer enters sleep mode if no button press occurs for 20 minutes. Pressing any button wakes the thermometer and returns it to its previous state. Sleep mode becomes enabled each time you turn on the thermometer and is automatically disabled in MIN MAX mode.*

#### *Line frequency:*

*For optimum rejection of line noise, the thermometer must be set for the local line frequency.*

## Measuring Temperatures

### Connecting a Thermocouple

To change the thermocouple type, see “Changing Setup Options.” The North American ANSI Color Code is:

Type	J	K	E	T	N
Color	Black	Yellow	Purple	Blue	Orange

1. Plug a thermocouple into the input connector(s).  
(Make sure that the polarity is correct.)
2. Set the thermometer for the correct thermocouple type.

### Displaying Temperatures

1. Press **°C/F/K** to select the correct temperature scale.
2. Hold or attach the thermocouple(s) to the measurement location.

The temperature reading appears in the primary display.

3. *Model 52:* Press **T1  
T2  
T1-T2** to toggle between showing the T1, T2, and T1-T2 readings in the primary or secondary display.

### Notes

*The display shows "- - -" when a thermocouple is not connected.*

*The display shows **OL** (overload) when the temperature being measured is outside the thermocouple's valid range.*

*Model 52: If only thermocouple T2 is connected, the T2 reading appears in the primary display.*

### **Holding the Displayed Readings**

1. Press **HOLD** to freeze the readings on the display.

The display shows **HOLD**.

2. *Model 52:* Press  to toggle showing the T1, T2, or T1-T2 readings in the primary or secondary display.
3. Press **HOLD** again to turn off the HOLD function.

### **Viewing the MIN, MAX, and AVG Readings**

1. Press  to step through the maximum (MAX), minimum (MIN), or the average (AVG) readings.

The elapsed time since entering MIN MAX mode, or the time at which the minimum or maximum occurred, appears on the display.

2. Press ,  (CANCEL) to exit MIN MAX mode.

### **Using the Offset to Adjust for Probe Errors**

Use the offset option in Setup to adjust the thermometer's readings to compensate for the errors of a specific thermocouple.

The allowable adjustment range is  $\pm 5.0$  °C or K, and  $\pm 9.0$  °F.

1. Plug the thermocouple into the input connector.
2. Place the thermocouple in a known, stable temperature environment (such as an ice bath or a dry well calibrator).
3. Allow the readings to stabilize.
4. In Setup change the offset until the primary display reading matches the calibration temperature. (See "Changing Setup Options.")



## **Maintenance**

### **Replacing the Batteries**

Refer to the safety information in Table 1 before replacing the batteries.

1. Turn off the thermometer if necessary.
2. Loosen the screw and remove the battery door.
3. Replace the three AA batteries.
4. Replace the battery door and tighten the screw.

### **Cleaning the Case and Holster**

Use soap and water or a mild commercial cleaner.

Wipe with a damp sponge or soft rag.

## **Calibration**

To ensure that the thermometer performs to its accuracy specifications, Fluke recommends that you calibrate the thermometer annually, starting one year after purchase.

To calibrate the thermometer, contact Fluke for the Service Center nearest you or follow the calibration procedure in the service manual listed in "Replacement Parts and Accessories."

## **Specifications**

### **Environmental**

<b>Operating Temperature</b>	-10 °C to 50 °C (14 °F to 122 °F)
<b>Storage Temperature</b>	-40 °C to +60 °C (-40 °F to +140 °F)
<b>Humidity</b>	Non condensing <10 °C (<50 °F) 95 % RH: 10 °C to 30 °C (50 °F to 86 °F) 75 % RH: 30 °C to 40 °C (86 °F to 104 °F) 45 % RH: 40 °C to 50 °C (104 °F to 122 °F)

**General**

<b>Weight</b>	280 g (10 oz)
<b>Dimensions (without holster)</b>	2.8 cm × 7.8 cm × 16.2 cm (1.1 in × 3 in × 6.4 in)
<b>Battery</b>	3 AA batteries
<b>Certification</b>	CE, 
<b>Safety</b>	CAN/CSA C22.2 No. 61010-1-04, ANSI/UL 61010-1:2004, EN/IEC 61010-1:2001
<b>EMC</b>	EN/IEC 61326-1:2006
<b>CAT I</b>	OVERVOLTAGE (Installation) CATEGORY I, Pollution Degree 2 per IEC1010-1*
* Refers to the level of Impulse Withstand Voltage protection provided. Category 1 products should not be attached to mains circuits.	

**80 PK-1 Thermocouple (supplied with thermometer)**

<b>Type</b>	Type K, Chromel Alumel, bead style
<b>Temperature Range</b>	-40 °C to +260 °C (-40 °F to +500 °F)
<b>Accuracy</b>	± 1.1 °C (± 2.0 °F)

**Electrical**

<b>Measurement Range</b>	J-type: -210 °C to +1200 °C (-346 °F to + 2192 °F)  K-type: -200 °C to +1372 °C (-328 °F to +2501 °F)  T-type: -250 °C to +400 °C (-418 °F to +752 °F)  E-type: -150 °C to +1000 °C (-238 °F to +1832 °F)
<b>Display Resolution</b>	0.1 °C / °F / K <1000° 1.0 °C / °F / K ≥1000°

**Electrical (cont.)**

<b>Measurement Accuracy, T1, T2, or T1-T2 (Model 52)</b>	J-, K-, T-, and E-type: $\pm[0.05\% \text{ of reading} + 0.3\text{ }^\circ\text{C} (0.5\text{ }^\circ\text{F})]$ [below $-100\text{ }^\circ\text{C} (-148\text{ }^\circ\text{F})$ : add 0.15 % of reading for J-, K-, E-, and N-type; and 0.45 % of reading for T-type]
<b>Temperature Coefficient</b>	0.01 % of reading + 0.03 $^\circ\text{C}$ per $^\circ\text{C}$ (0.05 $^\circ\text{F}$ per $^\circ\text{F}$ ) outside the specified $+18\text{ }^\circ\text{C}$ to $28\text{ }^\circ\text{C}$ ( $+64\text{ }^\circ\text{F}$ to $+82\text{ }^\circ\text{F}$ ) range [below $-100\text{ }^\circ\text{C} (-148\text{ }^\circ\text{F})$ : add 0.04 % of reading for J-, K-, E-, and N-type; and 0.08 % of reading for T-type]
<b>Electromagnetic Compatibility</b>	Susceptibility: $\pm 2\text{ }^\circ\text{C}$ ( $\pm 3.6\text{ }^\circ\text{F}$ ) for 80 MHz to 200 MHz in 1.5 V/m field, for 200 MHz to 1000 MHz in 3 V/m field. Emissions: Commercial Limits per EN50081-1
<b>Maximum Differential Common Mode Voltage</b>	1 V (Maximum voltage difference between T1 and T2)
<b>Temperature Scale</b>	ITS-90

<b>Applicable Standards</b>	NIST-175
Accuracy is specified for ambient temperatures between $18\text{ }^\circ\text{C}$ ( $64\text{ }^\circ\text{F}$ ) and $28\text{ }^\circ\text{C}$ ( $82\text{ }^\circ\text{F}$ ) for a period of 1 year. The above specifications do not include thermocouple error.	

**Replacement Parts and Accessories**

<b>Accessory</b>	<b>Part Number</b>
Holster and Flex Stand™ Assembly	1272438
AA NEDA 15A IEC LR6 batteries	376756
80PK-1 K-Type Bead Thermocouple	773135
CD-ROM	1276106
Service Manual	1276123



**FLUKE**®

# **53 & 54 Series II**

Thermometer

Users Manual

September 1999 Rev.1, 6/01

© 1999-2001 Fluke Corporation, All rights reserved. Printed in USA  
All product names are trademarks of their respective companies.

### **Limited Warranty & Limitation Of Liability**

This Fluke product will be free from defects in material and workmanship for 3 years from the date of purchase. This warranty does not cover fuses, disposable batteries or damage from accident, neglect, misuse or abnormal conditions of operation or handling. Resellers are not authorized to extend any other warranty on Fluke's behalf. To obtain service during the warranty period, send your defective tester to the nearest Fluke Authorized Service Center with a description of the problem.

THIS WARRANTY IS YOUR ONLY REMEDY. NO OTHER WARRANTIES, SUCH AS FITNESS FOR A PARTICULAR PURPOSE, ARE EXPRESSED OR IMPLIED. FLUKE IS NOT LIABLE FOR ANY SPECIAL, INDIRECT, INCIDENTAL OR CONSEQUENTIAL DAMAGES OR LOSSES, ARISING FROM ANY CAUSE OR THEORY. Since some states or countries do not allow the exclusion or limitation of an implied warranty or of incidental or consequential damages, this limitation of liability may not apply to you.

Fluke Corporation  
P.O. Box 9090  
Everett WA  
98206-9090

Fluke Europe B.V.  
P.O. Box 1186  
5602 B.D. Eindhoven  
The Netherlands

To register your product, visit [www.fluke-warranty.com](http://www.fluke-warranty.com)

# Table of Contents

Title	Page
Safety Information.....	1
Contacting Fluke .....	1
Getting Started.....	4
Components.....	5
Display Elements .....	6
Buttons.....	7
Using the Thermometer .....	9
Changing Setup Options.....	9
Entering and Exiting Setup.....	9
Changing the Logging Interval .....	10
Changing the Thermocouple Type.....	11
Changing the Offset.....	11
Enabling or Disabling Sleep Mode .....	12
Setting the Time.....	12
Changing the Line Frequency .....	13
Measuring Temperatures.....	13
Connecting a Thermocouple .....	13

Displaying Temperatures.....	14
Holding the Displayed Temperatures .....	14
Viewing the MIN, MAX, and AVG Readings .....	14
Using the Offset to Adjust for Probe Errors .....	15
Using Memory .....	15
Initial Conditions and Data Entries.....	16
Starting and Stopping Logging .....	16
Clearing Memory .....	17
Viewing Logged Readings.....	17
Communicating with a PC .....	18
Maintenance.....	19
Replacing the Batteries .....	19
Cleaning the Case and Holster.....	19
Calibration .....	19
Specifications .....	19
Environmental.....	19
General.....	20
80 PK-1 Thermocouple (supplied with thermometer) .....	20
Electrical.....	20
Replacement Parts and Accessories.....	21



## ***53 & 54 Series II***

### ***Safety Information***

The Fluke Model 53 and Model 54 Thermometers (“the thermometer”) are microprocessor-based, digital thermometers designed to use external J-, K-, T-, E-, R-, S-, and N-type thermocouples (temperature probes) as temperature sensors.

Use the thermometer only as specified in this manual. Otherwise, the protection provided by the meter may be impaired.

Refer to safety information in Table 1 and the meter symbols in Table 2.

### ***Contacting Fluke***

To order accessories, receive assistance, or locate the nearest Fluke distributor or Service Center, call:

1-888-99-FLUKE (1-888-993-5853) in USA

1-800-36-FLUKE (1-800-363-5853) in Canada

+31-402-678-200 in Europe

+81-3-3434-0181 in Japan

+65-738-5655 in Singapore

+1-425-446-5500 from other countries

Address correspondence to:

Fluke Corporation

P.O. Box 9090

Everett, WA 98206-9090

USA

Fluke Europe B.V.

P.O. Box 1186

5602 BD Eindhoven

The Netherlands

Visit us on the World Wide Web at: [www.fluke.com](http://www.fluke.com)

To register your product, visit [www.fluke-warranty.com](http://www.fluke-warranty.com)

**Table 1. Safety Information**

**⚠ Warning**

**A Warning identifies conditions and actions that pose hazards to the user. To avoid electrical shock or personal injury, follow these guidelines:**

- **Before using the thermometer inspect the case. Do not use the thermometer if it appears damaged. Look for cracks or missing plastic. Pay particular attention to the insulation around the connectors.**
- **Disconnect the thermocouple(s) from the thermometer before opening the case.**
- **Replace the batteries as soon as the battery indicator (🔋) appears. The possibility of false readings can lead to personal injury.**
- **Do not use the thermometer if it operates abnormally. Protection may be impaired. When in doubt, have the thermometer serviced.**
- **Do not operate the thermometer around explosive gas, vapor, or dust.**
- **Do not apply more than the rated voltage, as marked on the thermometer, between the thermocouple(s), or between any thermocouple and earth ground.**

**Table 1. Safety Information (cont.)**

**⚠ Warning (cont.)**





- **Model 54: Measurement errors may occur if voltages on the measurement surfaces result in potentials greater than 1 V between the two thermocouples. When potential differences are anticipated between the thermocouples, use electrically insulated thermocouples.**
- **When servicing the thermometer, use only specified replacement parts.**
- **Do not use the thermometer with any part of the case or cover removed.**

**Caution**

**A Caution identifies conditions and actions that may damage the meter or the equipment under test.**

- **Use the proper thermocouples, function, and range for your thermometer.**
- **Do not attempt to recharge the batteries.**
- **To prevent explosion, do not throw batteries into a fire.**
- **Follow local laws or regulations when disposing of batteries.**
- **Match the + and – polarities of the battery with the battery case.**

**Table 2. International Symbols**

	Refer to the manual for information about this feature.		Complies with European Union directives.
	Battery.		Complies with relevant Canadian Standards Association directives.

### **Getting Started**

Everything in this *Users Manual* applies both to Models 53 and 54 unless otherwise indicated.

To become familiar with the thermometer, study the following:

- Figure 1 and Table 3 describe the components.
- Figure 2 and Table 4 describe the display.
- Table 5 describes the functions of the buttons.

Then read the following sections.

**Components**

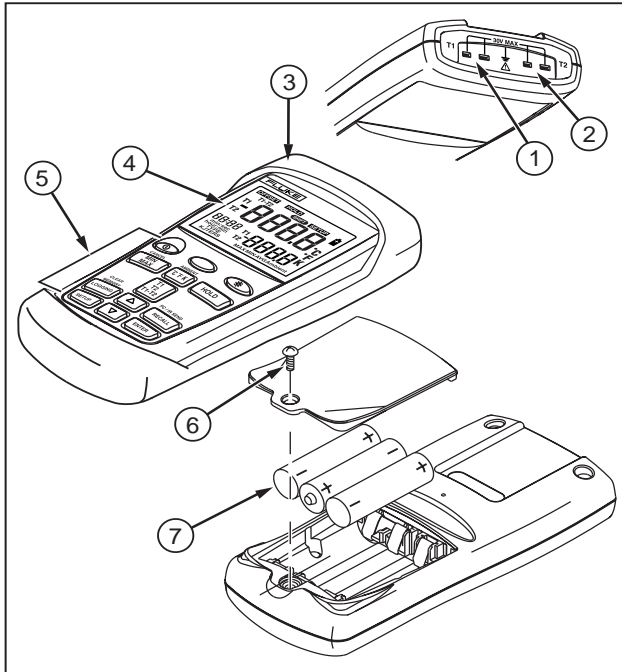

aat01f.eps

**Figure 1. Components**

**Table 3. Components**

①	Thermocouple T1 input
②	<i>Model 54:</i> Thermocouple T2 input
③	Holster
④	Display
⑤	Buttons
⑥	Battery door
⑦	Batteries

## Display Elements

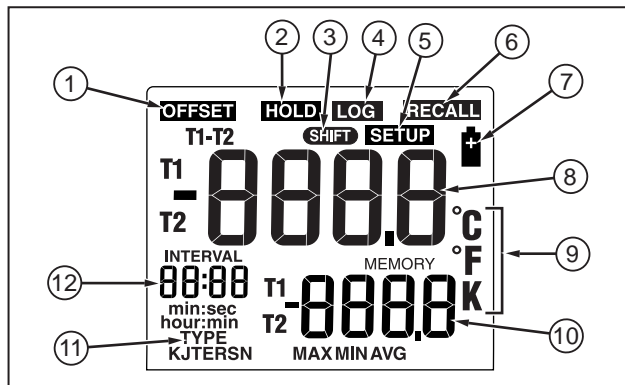

Figure 2. Display Elements

















aat02f.eps

Table 4. Display Elements























①	The thermocouple measurement includes an offset. See "Changing Setup Options."
②	The displayed readings do not change.
③	A shift function is in progress.
④	Readings are being logged.
⑤	Setup is in progress.
⑥	Logged readings are displayed.
⑦	Low battery. Replace the batteries.
⑧	Primary Display. <i>Model 53</i> : T1 reading. <i>Model 54</i> : T1, T2, or T1-T2 reading.
⑨	The temperature units.
⑩	Secondary Display: MAX, MIN, AVG, MEMORY, or offset. <i>Model 54</i> : T1 or T2 reading.
⑪	The thermocouple type.
⑫	Time Display: 24-hour clock. Shows the INTERVAL length in SETUP. Shows elapsed time when AVG is on or before clock has been set.

**Buttons**

**Table 5. Buttons**

	<p>Press  to turn the thermometer on or off.</p>
<p> (Shift function)</p>	<p>Press ,  (CANCEL) to stop displaying the minimum, maximum, and average readings in the secondary display.</p> <p>Press ,  (CLEAR MEMORY) to delete logged readings from memory.</p> <p>Press ,  (PC/IR SEND) to toggle the IR port on and off.</p>
	<p>Press  to turn the backlight on and off. The backlight turns off after 2 minutes without any button presses. If the battery is low, the backlight is disabled.</p>
	<p>Press  to step through the maximum, minimum, and average readings.</p> <p>When viewing logged readings, shows the maximum, minimum, and average of the logged readings.</p> <p>Press ,  (CANCEL) to turn off this display.</p>
	<p>Press  to switch between Celsius (°C), Fahrenheit (°F), and Kelvin (K).</p>

**Table 5. Buttons (cont.)**

	<p>Press  to freeze or unfreeze the displayed readings.</p> <p>Press  when turning on the thermometer to test the display. All display elements appear.</p>
	<p><i>Model 54:</i> Press  to toggle showing the T1, T2, and T1-T2 (differential temperature measurement) in the primary or secondary display.</p>
	<p>Press  to start or exit Setup. (See "Changing Setup Options.")</p>
	<p>Press  to scroll to the Setup option you want to change.</p> <p>Press  to increase the displayed setting.</p>
	<p>Press  to scroll to the Setup option you want to change.</p> <p>Press  to decrease the displayed setting.</p>
	<p>Press  to enter a Setup option.</p> <p>Press  again to store the displayed setting in memory.</p>
	<p>Press  to start or stop logging.</p> <p>During manual logging, the thermometer stores a single set of logged readings in memory each time you press .</p>
	<p>Press  to show logged readings and MIN MAX readings on the display.</p> <p>Press  again to stop.</p>



## **Using the Thermometer**

1. Plug the thermocouple(s) into the input connector(s).
2. Press  to turn on the thermometer.

After 1 second the thermometer displays the first reading. If no thermocouple is plugged into the selected input or the thermocouple is "open," the display shows "----."

## **Changing Setup Options**

Use Setup to change the logging interval, thermocouple type, offset, sleep mode, time, and line frequency settings.



The thermometer stores the settings in its memory. Setup settings reset only when the batteries are removed for more than 2 minutes.

## **Entering and Exiting Setup**

When the thermometer is in Setup mode, the display shows **SETUP**.

- Press  to start or exit Setup.

### *Notes*

Press  or  to scroll to the setup option you want to change.

*Setup is disabled in MIN MAX mode.*

### **Changing the Logging Interval**

The logging interval determines how often the thermometer stores logged readings in memory. You choose the length of the logging interval. See "Using Memory."

The thermometer stores logged readings at the end of each logging interval. You can select a logging interval of 1 second (**1**), 10 seconds (**2**), 1 minute (**3**), 10 minutes (**4**), or user-defined (**USER**).

You can also set the logging interval manually (**0**). Each time you press **LOGGING**, the thermometer stores the current readings in memory.

1. Press **▲** or **▼** until the display shows **INTERVAL**.
2. Press **ENTER** to display the logging interval choices.
3. Press **▲** or **▼** until the display shows the logging interval you want, and then press **ENTER** to select.

4. If you selected a user-defined logging interval:

- Press **▲** or **▼** until the display shows **hour:min** or **min:sec**, and then press **ENTER** to select.

The left two digits blink.

- Press **▲** or **▼** until the left two digits you want appear on the display, and then press **ENTER** to select them.

The right two digits blink.

- Press **▲** or **▼** until the right two digits you want appear on the display, and then press **ENTER** to select them.

Holding down **▲** or **▼** causes the number to change more quickly.

### Changing the Thermocouple Type

1. Press  or  until the display shows **TYPE**.
2. Press  to display the thermocouple type choices.  
  
The currently selected thermocouple blinks.
3. Press  or  until the thermocouple you want appears on the display.
4. Press  to store the thermocouple type in memory.

### Changing the Offset

You can adjust the thermometer's readings to compensate for the errors of a specific thermocouple. See "Using the Offset to Adjust for Probe Errors." The allowable adjustment range is  $\pm 5.0$  °C or K, and  $\pm 9.0$  °F.

*Model 54:* You can store individual offsets for T1 and T2.

1. Press  or  until the display shows **OFFSET** and **T1** or **T2**.
2. Press  to indicate that you want to change the offset setting.  
  
The temperature measurement plus the offset appears in the primary display. The offset appears in the secondary display.
3. Press  or  until the primary display shows the correct reading.
4. Press  to store the offset setting in memory.

Remember to reset the offset to 0.0 when it is no longer needed. The offset automatically resets to 0.0 when you change the thermocouple type.

### **Enabling or Disabling Sleep Mode**

The thermometer enters sleep mode if no button press occurs for 20 minutes.

Pressing any button wakes the thermometer and returns it to its previous state.

1. Press  or  until the display shows **SLP**.
2. Press  to indicate that you want to change the sleep setting.

The display shows **ON** if sleep mode is on and **OFF** if sleep mode is off.

3. Press  or  as needed until the display shows **ON** or **OFF**.
4. Press  to store the sleep setting in memory.

Sleep mode is enabled each time you turn on the thermometer and is automatically disabled in MIN MAX and logging modes.

### **Setting the Time**

1. Press  or  until the display shows the time if it is set or shows "- - : - -."

2. Press  to indicate you want to set the time.

The left two digits blink.

3. Press  or  until the display shows the correct hour (24-hour format), and then press  to select.

The right two digits blink.







4. Press  or  until the display shows the correct minutes, and then press  to store the time in memory.

#### *Note*

*Holding down  or  causes the number to change more quickly.*

### **Changing the Line Frequency**

For optimum rejection of line noise, set the thermometer for the local line frequency as follows:

1. Press  or  until the display shows  $L_{LINE}$ .
2. Press  to indicate that you want to change the line setting.
3. Press  or  as needed until the display shows 50 H or 60 H (50 Hz or 60 Hz).
4. Press  to store the line setting in memory.

### **Measuring Temperatures**

#### **Connecting a Thermocouple**



Thermocouples are color coded by type based on the North American ANSI Color Code:

Type	Color	Type	Color
J	Black	R	Green
K	Yellow	S	Green
T	Blue	N	Orange
E	Purple		

1. Plug a thermocouple into the input connector(s).
2. Set the thermometer for the correct thermocouple type.

To change the thermocouple type, see “Changing Setup Options.”

## Displaying Temperatures

1. Press  to select the correct temperature scale.
2. Hold or attach the thermocouple(s) to the measurement location.  
  
The temperature reading appears in the selected display.
3. *Model 54:* Press  to toggle between showing the T1, T2, and T1-T2 reading in the primary or secondary display.



### Notes

*The display shows "- - -" when a thermocouple is not connected.*

*The display shows  (overload) when the temperature being measured is outside the thermocouple's valid range.*

*Model 54: If only thermocouple T2 is connected, the T2 reading appears in the primary display.*

## Holding the Displayed Temperatures

1. Press  to freeze the readings on the display.  
  
The display shows **HOLD**.
2. *Model 54:* Press  to toggle showing the T1, T2, or T1-T2 readings in the primary or secondary display.
3. Press  again to turn off the HOLD function.

## Viewing the MIN, MAX, and AVG Readings

1. Press  to step through the maximum (MAX), minimum (MIN), or the average (AVG) readings.

The elapsed time since entering MIN MAX mode, or the time at which the minimum or maximum occurred, appears on the display.

2. Press ,  (CANCEL) to exit MIN MAX mode.

### ***Using the Offset to Adjust for Probe Errors***

Use the offset option in Setup to adjust the thermometer's readings to compensate for the errors of a specific thermocouple.

1. Plug the thermocouple into the input connector.
2. Place the thermocouple in a known, stable temperature environment (such as an ice bath or a dry well calibrator).
3. Allow the readings to stabilize.
4. In Setup change the offset until the primary display reading matches the calibration temperature. (See "Changing Setup Options.")

### ***Using Memory***

During a logging session the thermometer stores logged readings in its memory.

At the end of the logging session you can view the logged readings on the display.

You can also transfer the logged readings to a PC running *FlukeView Forms* software. (See "Communicating with a PC.")

*FlukeView Forms* displays the logged readings on an online form, which you can print or store for later use.

### **Initial Conditions and Data Entries**

Logged readings include *initial conditions* and *data entries*.

The initial conditions are the thermocouple type and the offsets for each thermocouple input. You can only view initial conditions using *FlukeView Forms*.

The data entries are a time stamp, the T1 reading, and the T2 and T1-T2 readings (*Model 54*). You can view these values by pressing  or using *FlukeView Forms*. Temperature readings display 0.1 degree resolution in *FlukeView Forms*.

The thermometer has 500 memory locations. The thermometer stores 499 sets of temperature readings and one set of initial conditions when logging continuously. It stores 250 sets of temperature readings and 250 sets of initial conditions when logging individual points manually.

### **Starting and Stopping Logging**

Setup, memory clear, and PC communications are inaccessible during logging.

1. Set the logging interval. (See “Changing Setup Options.”)

2. Press  to start logging.

The display shows **LOG**.



3. Press  again to stop logging.

4. If you selected a manual logging interval, press  each time you want to store logged readings in memory.



## Clearing Memory

When memory is full, Full appears on the display and logging stops. You can clear memory in normal or MIN MAX mode.

- Press ,  (CLEAR MEMORY) to delete logged readings from memory.

The display shows the following for 2 seconds.





MEMORY  
[ 1 ] r

## Viewing Logged Readings

1. Press  to view logged readings.

The display shows **RECALL**.

2. Press  or  to scroll through the logged readings.

The display shows each logged reading, its time stamp, and its memory location. For example, Figure 3 shows the logged reading stored at 2:02 PM in memory location 18.

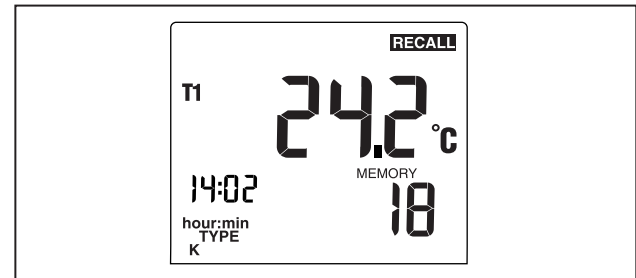
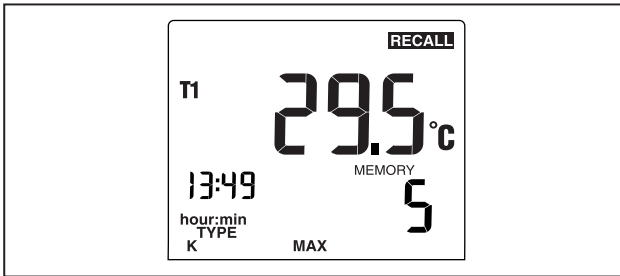

Figure 3. Logged Reading

aat03f.eps

- Press **MIN MAX** to step through the minimum, maximum, average, and current logged reading. For example, Figure 4 shows the maximum reading in memory. The maximum reading occurred at 1:49 P.M. and was stored in memory location 5.



aat04f.eps

Figure 4. Maximum Reading

- Press **RECALL** to stop viewing logged readings.

*Note*

*The thermometer calculates the minimum and maximum of all logging sessions in memory.*

*The display shows "- - : - -" if the log is empty.*

## Communicating with a PC

You can transfer the contents of the thermometer's memory to a PC using *FlukeView Forms*. The communication requires an IR (infrared) serial connection. Refer to the *FlukeView Forms Installation Guide* and *FlukeView Help*.

*FlukeView Forms* places the logged readings into standard (default) or customized forms. The forms also display user comments. You can use these forms to satisfy ISO-9000 documentation requirements.

When you send logged readings to a PC, all functions are disabled except power off, backlight, and turning off communication.

- Press **IR SEND**, **RECALL** (PC/IR SEND) to toggle the IR port on and off.

The display shows:

IR  
SEND

When the IR port is enabled you can communicate with *FlukeView Forms*.

## **Maintenance**

### **Replacing the Batteries**

Refer to the safety information in Table 1 before replacing the batteries.

1. Turn off the thermometer if necessary.
2. Loosen the screw and remove the battery door.
3. Replace the three AA batteries.
4. Replace the battery door and tighten the screw.

### **Cleaning the Case and Holster**

Use soap and water or a mild commercial cleaner.

Wipe with a damp sponge or soft rag.

## **Calibration**

To ensure that the thermometer performs to its accuracy specifications, Fluke recommends that you calibrate the thermometer annually, starting one year after purchase.



To calibrate the thermometer, contact Fluke for the Service Center nearest you or follow the calibration procedure in the service manual listed in "Replacement Parts and Accessories."

## **Specifications**

### **Environmental**

<b>Operating Temperature</b>	-10 °C to 50 °C (14 °F to 122 °F)
<b>Storage Temperature</b>	-40 °C to +60 °C (-40 °F to +140 °F)
<b>Humidity</b>	Non condensing <10 °C (<50 °F) 95% RH: 10 °C to 30 °C (50 °F to 86 °F) 75% RH: 30 °C to 40 °C (86 °F to 104 °F) 45% RH: 40 °C to 50 °C (104 °F to 122 °F)

**General**

<b>Weight</b>	280 g (10 oz)
<b>Dimensions (without holster)</b>	2.8 cm × 7.8 cm × 16.2 cm (1.1 in × 3 in × 6.4 in)
<b>Battery</b>	3 AA batteries
<b>Certification</b>	CE,  
<b>Safety</b>	CSA C22.2 No. 1010.1 1992 EN 61010 Amendments 1, 2
<b>CAT I</b>	OVERVOLTAGE (Installation) CATEGORY I, Pollution Degree 2 per IEC1010-1*
* Refers to the level of Impulse Withstand Voltage protection provided. Equipment of OVERVOLTAGE CATEGORY I is equipment for connection to circuits in which measures are taken to limit the transient over voltages to an appropriate low level. Example include protect electronic circuits.	

**80 PK-1 Thermocouple (supplied with thermometer)**

<b>Type</b>	Type K, Chromel Alumel, bead style
<b>Temperature Range</b>	-40 °C to +260 °C (-40 °F to +500 °F)
<b>Accuracy</b>	± 1.1 °C (± 2.0 °F)

**Electrical**

<b>Measurement Range</b>	J-type: -210 °C to +1200 °C (-346 °F to + 2192 °F) K-type: -200 °C to +1372 °C (-328 °F to +2501 °F) T-type: -250 °C to +400 °C (-418 °F to +752 °F) E-type: -150 °C to +1000 °C (-238 °F to +1832 °F) N-type: -200 °C to +1300 °C (-328 °F to +2372 °F) R- and S-type: 0 °C to +1767 °C (+32 °F to +3212 °F)
<b>Display Resolution</b>	0.1 °C / °F / K < 1000° 1.0 °C / °F / K ≥ 1000°

**Electrical (cont.)**

<b>Measurement Accuracy, T1, T2 or T1-T2 (Model 54)</b>	J-, K-, T-, E-, and N-type: $\pm[0.05\% \text{ of reading} + 0.3\text{ }^{\circ}\text{C} (0.5\text{ }^{\circ}\text{F})]$ [below $-100\text{ }^{\circ}\text{C} (-148\text{ }^{\circ}\text{F})$ : add 0.15 % of reading for J-, K-, E-, and N-type; and 0.45 % of reading for T-type] R- and S-type: $\pm[0.05\% \text{ of reading} + 0.4\text{ }^{\circ}\text{C} (0.7\text{ }^{\circ}\text{F})]$
<b>Temperature Coefficient</b>	0.01 % of reading + 0.03 $^{\circ}\text{C}$ per $^{\circ}\text{C}$ (0.05 $^{\circ}\text{F}$ per $^{\circ}\text{F}$ ) outside the specified +18 $^{\circ}\text{C}$ to 28 $^{\circ}\text{C}$ (+64 $^{\circ}\text{F}$ to +82 $^{\circ}\text{F}$ ) range [below $-100\text{ }^{\circ}\text{C} (-148\text{ }^{\circ}\text{F})$ : add 0.04 % of reading for J-, K-, E-, and N-type; and 0.08 % of reading for T-type]
<b>Electromagnetic Compatibility</b>	Susceptibility: $\pm 2\text{ }^{\circ}\text{C} (\pm 3.6\text{ }^{\circ}\text{F})$ for 80 MHz to 200 MHz in 1.5 V/m field, for 200 MHz to 1000 MHz in 3 V/m field. Emmissions: Commercial Limits per EN50081-1
<b>Maximum Differential Common Mode Voltage</b>	1 V (Maximum voltage difference between T1 and T2)
<b>Temperature Scale</b>	ITS-90
<b>Applicable Standards</b>	NIST-175
Accuracy is specified for ambient temperatures between 18 $^{\circ}\text{C}$ (64 $^{\circ}\text{F}$ ) and 28 $^{\circ}\text{C}$ (82 $^{\circ}\text{F}$ ) for a period of 1 year. The above specifications do not include thermocouple error.	

**Replacement Parts and Accessories**

<b>Accessory</b>	<b>Part Number</b>
Holster and Flex Stand™ Assembly	1272438
AA NEDA 15A IEC LR6 batteries	376756
80PK-1 K-Type Bead Thermocouple	773135
CD-ROM	1276106
Service Manual	1276123

